

How to Install Water Level Sensor

Proteus L5 WiFi Water Level Sensor is designed to detect water/ liquids when it hits and pushes the float switch up. After you have completed the Wi-Fi Setup process outlined in the Quick Start Guide, Position the float switch at the height of water/ liquid that you want to be notified.

Got Additional Water Sensor/ Float Switches?

If you have more than one sensor cables, connect the sensor cables to the stereo or 5 way splitter that came with the package. Then connect the splitter male jack to the sensor port on the base unit.

Note that when you have multiple sensor cables connecting to the same base unit, they will not show up as individual sensors on the sensor cloud. Rather, they will show up as one single sensor. If any one of the cables detect water, alarm will trip and notifications will be sent. The alarm message WILL NOT identify which cable detected water.

Questions?

Write to us at support@proteussensor.com

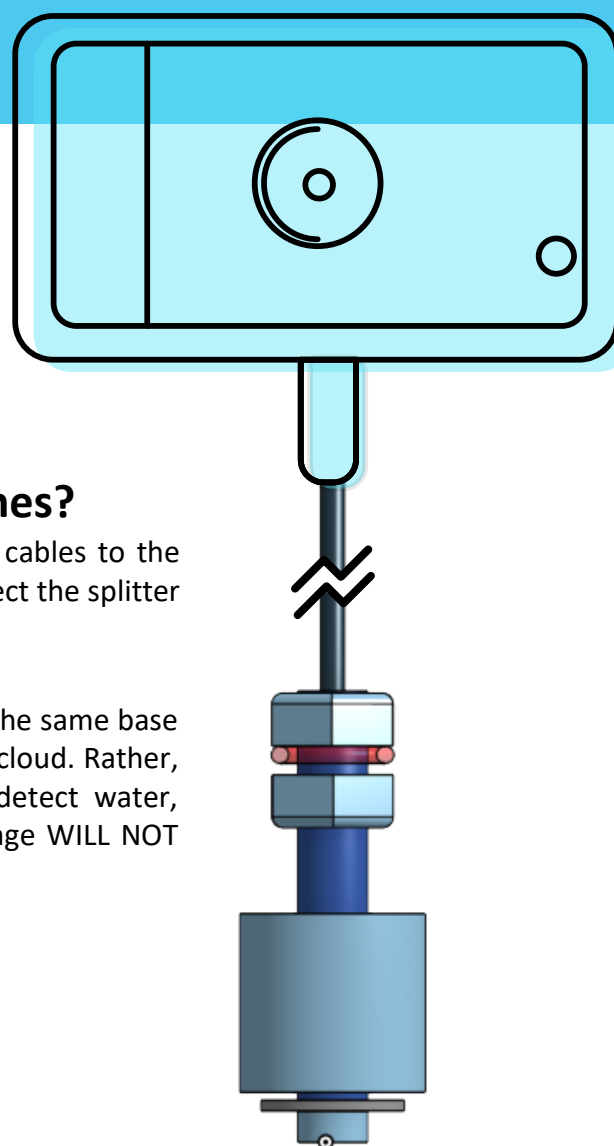

How It Works?

Proteus L5 Water Sensor trips when the bob on the float switch moves and opens or closes the magnetic switch inside the float.

Installing your Sensor

The float switch can be made to work in both normally low or normally high modes. In normally low mode, the bob is in the low position when there is no water. Water rises and hits the bob, pushing it up, there by tripping the alarm. The opposite happens in a normally high mode where the float switch remains submerged under water during normal operation. Alarm trips when level goes low.

Emails, Calls, Text Alerts

You can add your phone numbers, multiple emails to the notification list. No matter where you are, you can be in the know when water is detected.

Testing Your Sensor

After the installation is complete, move the float bob up or down and keep it there. In few seconds, the base unit will start beeping with the amber light flashing. This indicates the alarms have been tripped and you should get notifications shortly.

Got a splitter?

If you got a base unit with two or more sensor cables and a splitter, connect the male end of the splitter to the sensor port of the base unit. Then plug in the sensor cables to the splitter. This applies even if you got one water sensor cable and one level sensing float switch cable. Make sure the cables are pushed in all the way.

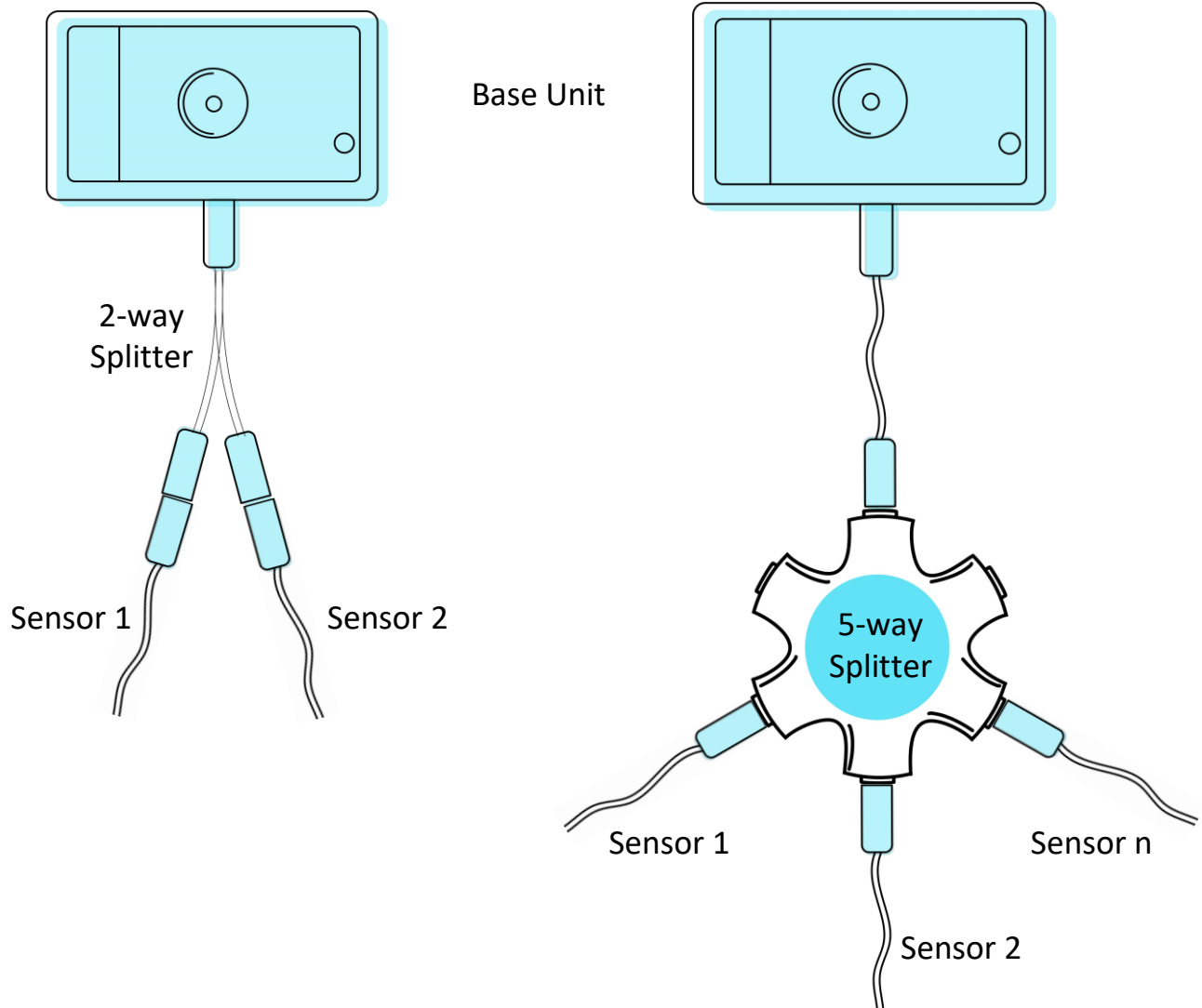

Proteus
Base Unit



Installing in your sump pit.

Position the Float Switch vertically, inside the sump pit, at a height few inches above the max water level. Ideally, water would never touch the float switch, as the pump will be flushing the water out. If and when the water reaches the float switch, it will push the bob up, and trips the alarm.

25' cable

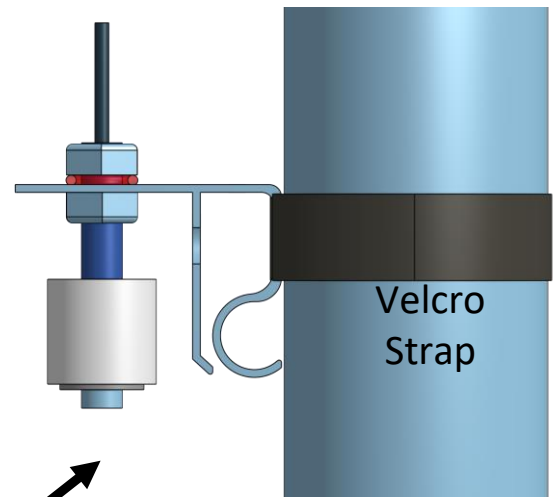

Velcro
Strap

Floor

Float
Mount

Discharge
Outlet

Water Inlet

PUMP

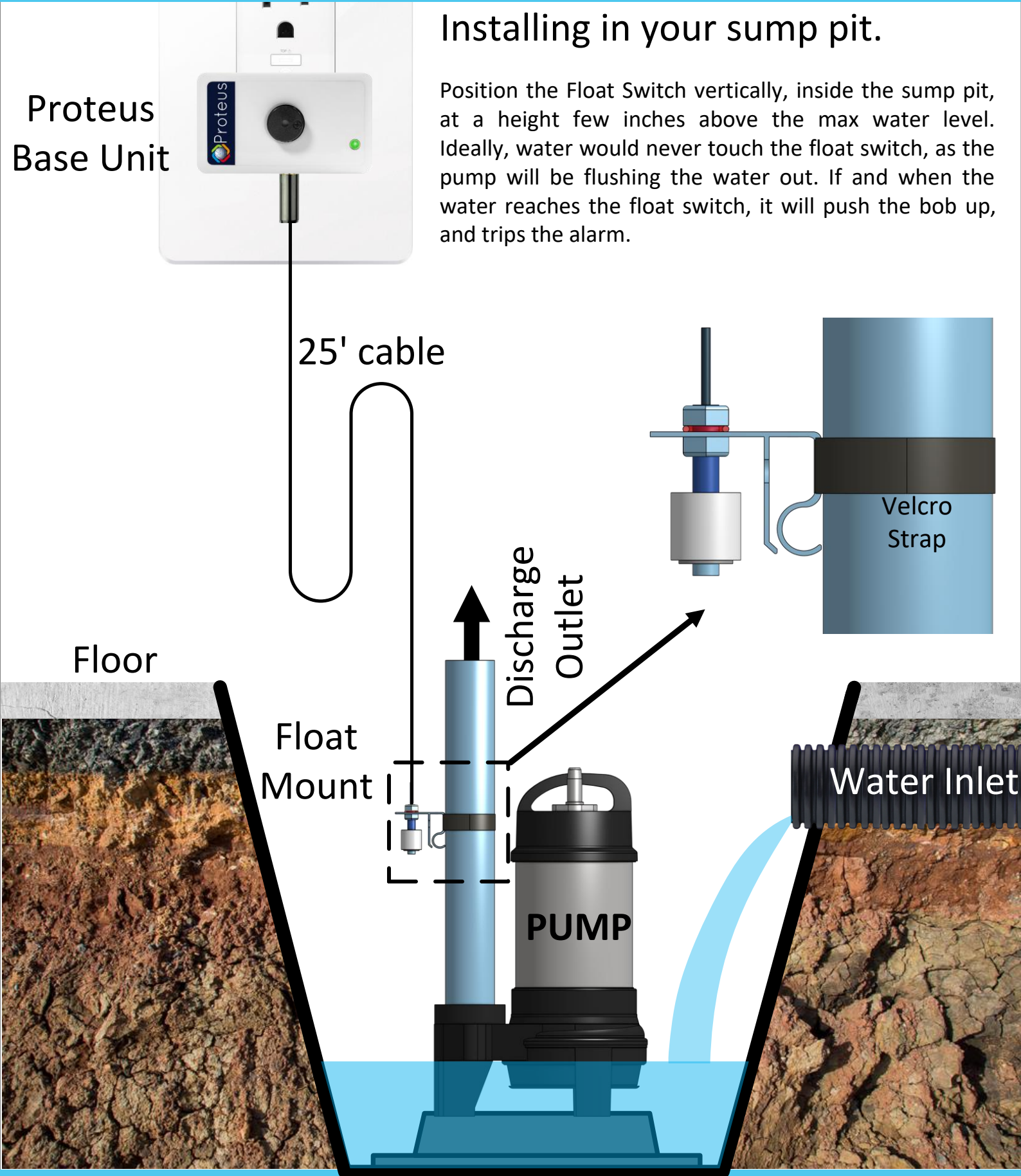

Positioning the sensor

The float switch sensor node comes with handy mounting accessories that lets you easily position the sensor at the height, and in locations you want. This can be a sump pit, water tank, holding tank, sewer tank, condensate pan or a variety of other applications.

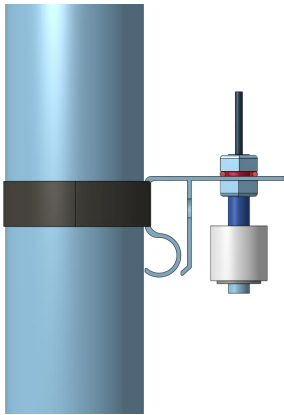

The easiest way is to attach the float clamp to a vertical pole or pipe using the reusable velcro band and place the float on the clamp..

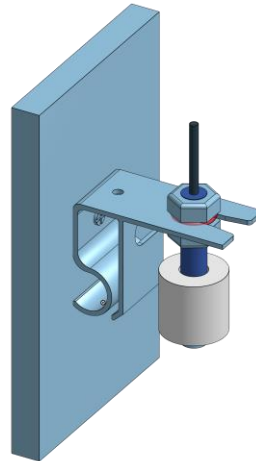

In spots closer to the wall, you can screw mount the sensor to the wall to keep it in position.

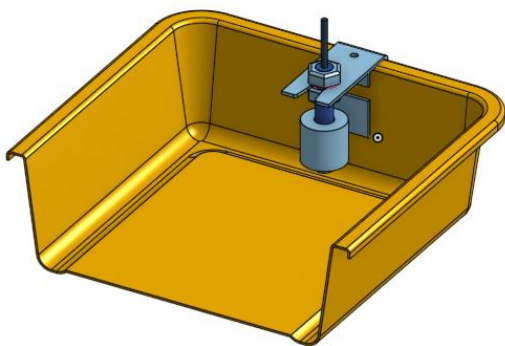

Monitoring a condensate pan? The float clamp is conveniently designed to snap on the lip of your pan so you can position the sensor at the top easily.

Sensor under water?

When placing the sensor submerged under water or other liquids, in “**Normally High**” mode of operation, it is important to keep the vertical position of the sensor intact. Since the float is very light, If positioning the sensor with the provided mounting hardware is not practical, hanging additional weight to the bottom of the clip is a simple and effective way to keep it in position.

